

# TRXF

Thermal-Link & Fusing Resistor

## TRXF2 Series (Axial Type)

### Description

Thermal-Link & Fusing Resistor (TRXF) is an unique type of Power Resistor, with Over Temp. and Over Current Protections. The Alloy Thermal-Link (ATCO) is built in the core of Fusible Wirewound Resistor (RXF) and in series with RXF.

TRXF is widely used in products such as general lighting, smart homes, small power home appliances, personal care application, security & protection.

SETsafe | SETfuse TRXF has the same physical size as ordinary RXF as well as large fault current protection. Besides, TRXF can effectively solve the hidden danger of continuous abnormal heat that ordinary RXF may cause when small fault current happens. TRXF1 series (Axial Type) Rated Resistance from 0.10 Ω to 1,000 Ω, Rated Functioning Temp: 221 °C, safety certification includes UL, TUV, CQC and complies with RoHS and REACH.

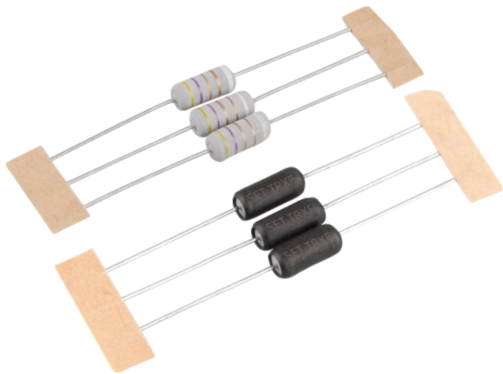

### Features

- Over Temp. Protection
- Over Current Protection
- Small Fault Current Protection
- Surge Protection
- Inrush Current Protection
- RoHS & REACH Compliant

### Applications

- Adapters
- Switched-Mode Power Supplies
- LED Drives
- Small Power Home Appliances
- Security & Protection

### Customization

- Vertical Taping Available
- Leads Forming Types
- Body with Tube

### Structure Diagrams

#### Axial Type

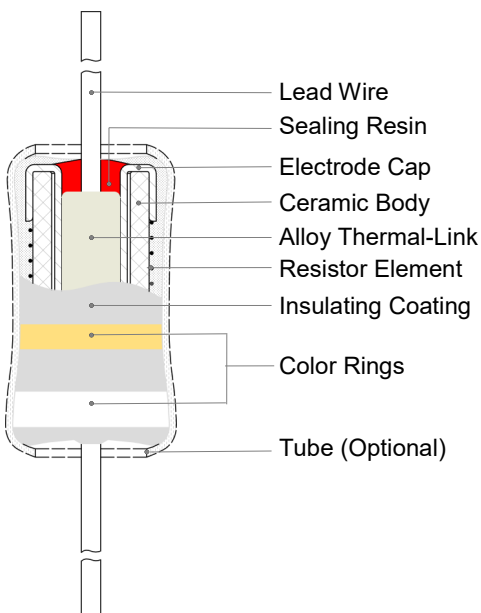

Note: The color of schematic diagram is for reference only

### Dimensions (mm)

#### Coating Type

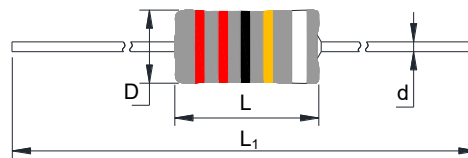

L	L <sub>1</sub> <sup>a</sup>	D	d
10.0 ± 1.0	60.0 ± 2.0 / 72.0 ± 2.0	Φ4.4 ± 0.5	Φ0.54 ± 0.05

#### With Tube

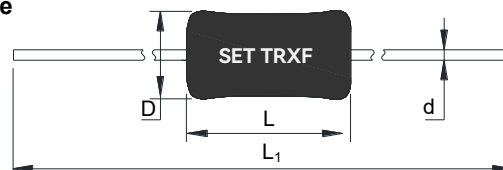

L	L <sub>1</sub> <sup>a</sup>	D	d
10.5 ± 1.0	60.0 ± 2.0 / 72.0 ± 2.0	Φ4.6 ± 0.5	Φ0.54 ± 0.05



Note: a - Blue font is SETsafe | SETfuse common length.

# TRXF

Thermal-Link & Fusing Resistor

## TRXF2 Series (Axial Type)

### Agency Information

Agency Symbol		Standards	The File No. and certification No. obtained by	Rated Resistance (Ω)
	UL	UL 1412	E324712	0.47 to 1,000
	CQC	SJ 2865	CQC18001205501	0.47 to 1,000
	TUV	EN IEC 60127	R50560302	0.1 to 1,000



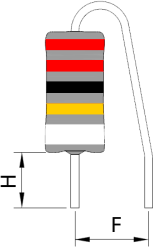
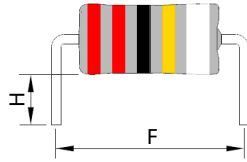
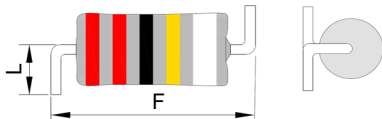





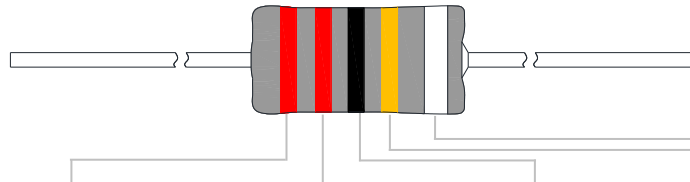



### Leads Forming Types

A		B		C	
					
H (mm)	F (mm)	H (mm)	F (mm)	L (mm)	F (mm)
3.5 ± 0.5	5.0 / 7.5 ± 1.5	3.5 ± 0.5	(12.0 ~ 18.0) ± 0.5	3.0 ± 0.5	13 ± 1

The forming modes and length of lead wires can be customized.

### Marking



Color	The First Number	The Second Number	Multiple	Resistance Tolerance	T <sub>f</sub>
	Black	0	0	10 <sup>0</sup>	N/A
	Brown	1	1	10 <sup>1</sup>	N/A
	Red	2	2	10 <sup>2</sup>	N/A
	Orange	3	3	10 <sup>3</sup>	N/A
	Yellow	4	4	10 <sup>4</sup>	N/A
	Green	5	5	10 <sup>5</sup>	N/A
	Blue	6	6	10 <sup>6</sup>	N/A
	Purple	7	7	10 <sup>7</sup>	N/A
	Grey	8	8	10 <sup>8</sup>	N/A
	White	9	9	10 <sup>9</sup>	221 °C
	Gold	N/A	N/A	10 <sup>-1</sup>	J: ±5%
	Silver	N/A	N/A	10 <sup>-2</sup>	K: ±10%

# TRXF

Thermal-Link & Fusing Resistor

## TRXF2 Series (Axial Type)

### Part Numbering System

TRXF 2 - 4R7 J 30 T D A - 001

<b>Other Options</b>	
<b>Tube</b>	
A :	Coating Type
B :	With Tube
<b>Case Type</b>	
D :	Coating
<b>Packaging Type</b>	
T :	Taping
B :	Bulk
<b>ATCO Code</b>	
30 :	H31 (221 °C)
<b>Tolerance</b>	
J :	±5%
K :	±10%
<b>Rated Resistance (Ω)</b>	
R47 :	0.47
47R :	47
4R7 :	4.7
470R :	470
<b>Power Type</b>	
2 :	2 W
<b>Product Category</b>	

### Technical Parameter

Item	Parameter
Power Type ( <i>P</i> )	2 W
Rated Resistance ( <i>R</i> )	0.1 Ω ~ 1,000 Ω
Resistance Tolerance	5% (E24), 10% (E12)
Derating Factor ( <i>f</i> )	See Rated Power Derating Curve
Actual Power ( <i>P</i> <sub>0</sub> )	$P_0 = P \times f$
Rated Current ( <i>I</i> <sub>N</sub> )	$I_N = \sqrt{P_0 / R}$
Rated Voltage ( <i>U</i> <sub>N</sub> )	$U_N = \sqrt{P_0 \times R}$
Fusing Time (less than 60 seconds)	$T_f = 221 \text{ °C}: 4 \times P_0$
Rated Functioning Temp. ( <i>T</i> <sub>f</sub> )	221 °C
Fusing Temp. ( <i>T</i> <sub>f</sub> )	$T_f = 221 \text{ °C}: 216 \text{ °C} \sim 221 \text{ °C}$
Surge (For Reference) Note: Combination Wave	2.0 kV ( <i>R</i> > 10 Ω)
	1.0 kV ( <i>R</i> ≤ 10 Ω)

### Rated Power Derating Curve (For Reference Only)

When the ambient temp. exceeds 25 °C, the rated power value declines as the following curve.

(The Max. working temp. of polyolefin tube is 125 °C )

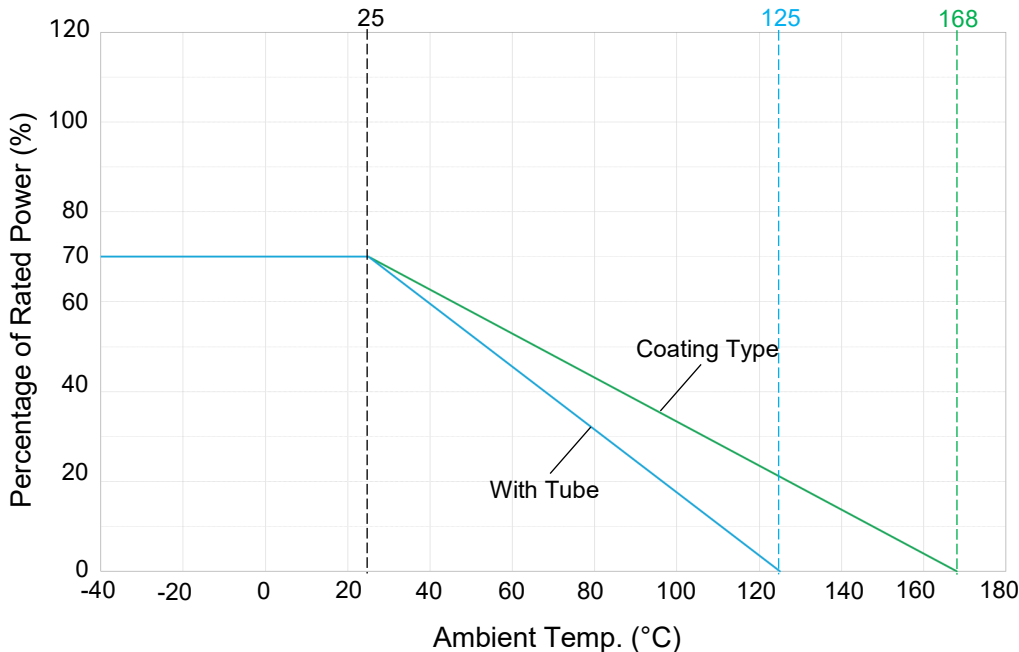



# TRXF

Thermal-Link & Fusing Resistor

## TRXF2 Series (Axial Type)

### Specifications

Series	Power Type	Derating Factor (25 °C)	Rated Resistance (R)	Resistance Tolerance	Rated Functioning Temp. (T <sub>f</sub> )	Fusing Temp. (T <sub>F</sub> )	Agency Information			Environmental Status	
										RoHS	REACH
	(W)	(%)	(Ω)	(%)	(°C)	(°C)	UL	TUV	CQC		
TRXF2 (Axial Type)	2	70	0.1 ~ 0.43 0.47 ~ 1,000	± 5, ± 10	221	216 ~ 221	N/A ●	● ●	N/A ●	●	●

Note: "●" Means certificated, RoHS & REACH Compliant .

Resistance Selection Table (According to IEC60063-2015, blue font is SETsafe | SETfuse common resistance).

Rated Resistance (Ω)	Code	Rated Resistance (Ω)	Code	Rated Resistance (Ω)	Code	Rated Resistance (Ω)	Code
0.10	R10	1.0	1R0	10	10R	100	100R
0.11	R11	1.1	1R1	11	11R	110	110R
0.12	R12	1.2	1R2	12	12R	120	120R
0.13	R13	1.3	1R3	13	13R	130	130R
0.15	R15	1.5	1R5	15	15R	150	150R
0.16	R16	1.6	1R6	16	16R	160	160R
0.18	R18	1.8	1R8	18	18R	180	180R
0.20	R20	2.0	2R0	20	20R	200	200R
0.22	R22	2.2	2R2	22	22R	220	220R
0.24	R24	2.4	2R4	24	24R	240	240R
0.27	R27	2.7	2R7	27	27R	270	270R
0.30	R30	3.0	3R0	30	30R	300	300R
0.33	R33	3.3	3R3	33	33R	330	330R
0.36	R36	3.6	3R6	36	36R	360	360R
0.39	R39	3.9	3R9	39	39R	390	390R
0.43	R43	4.3	4R3	43	43R	430	430R
0.47	R47	4.7	4R7	47	47R	470	470R
0.51	R51	5.1	5R1	51	51R	510	510R
0.56	R56	5.6	5R6	56	56R	560	560R
0.62	R62	6.2	6R2	62	62R	620	620R
0.68	R68	6.8	6R8	68	68R	680	680R
0.75	R75	7.5	7R5	75	75R	750	750R
0.82	R82	8.2	8R2	82	82R	800	800R
0.91	R91	9.1	9R1	91	91R	910	910R

# TRXF

Thermal-Link & Fusing Resistor

## TRXF2 Series (Axial Type)

### Fusing Time Curve (For Reference Only)

Compared with RXF, TRXF can open effectively at lower power multiples to protect the circuit timely.  
(ambient temp. 25 °C ± 2 °C)

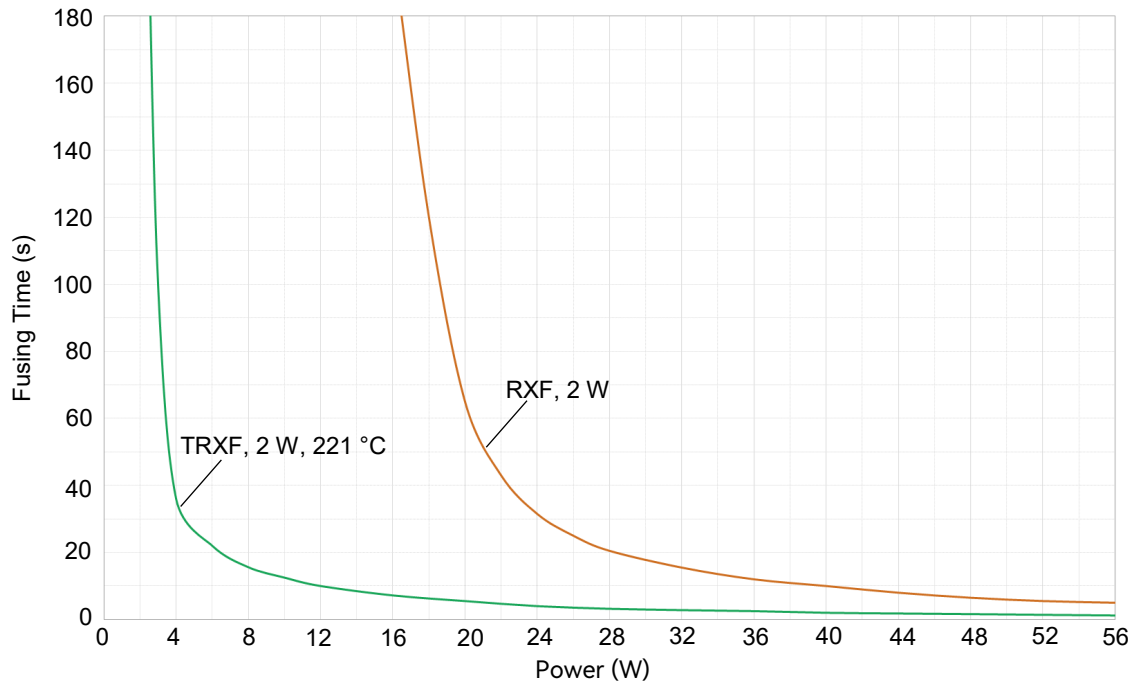

### Surface Temp. Curve (For Reference Only)

The surface temp. of TRXF is always at a lower level, when small fault current happens to the device, TRXF is able to open the circuit timely without additional damage (ambient temp. 25 °C ± 2 °C).

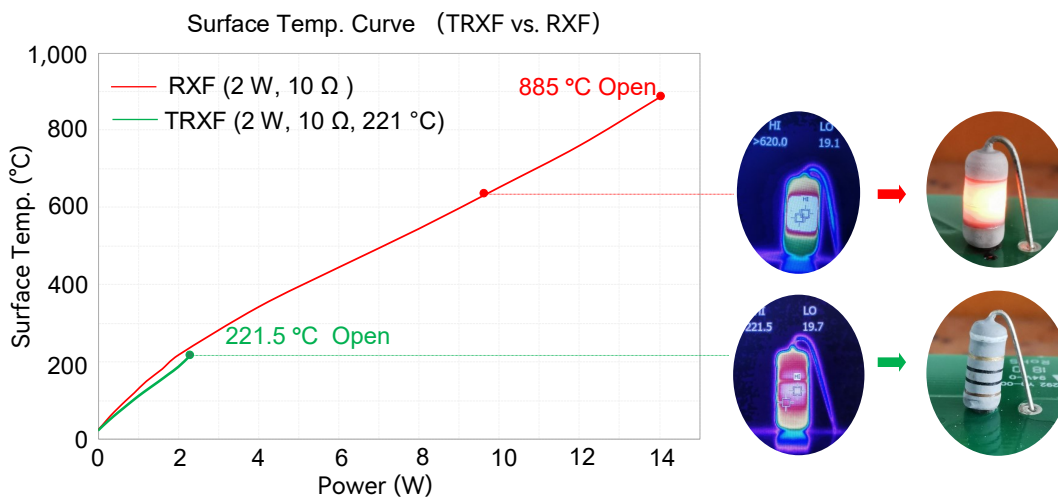

# TRXF

Thermal-Link & Fusing Resistor

## TRXF2 Series (Axial Type)

### Packaging Information

#### Horizontal Taping

Tota Length	Item	Box	Carton
60	Quantity (PCS)	1,000	10,000
	Gross Weight (kg)	7 ± 10%	
72	Quantity (PCS)	1,000	8,000
	Gross Weight (kg)	6.9 ± 10%	

Tape Dimensions (mm)		
Symbol	Total Length	
	60 mm	72 mm
W	52 ± 2	64 ± 2
L	Coating Type	10.0 ± 1.0
	With Tube	10.5 ± 1.0
W <sub>1</sub> - W <sub>2</sub>	2.0 Max.	

Unit: mm

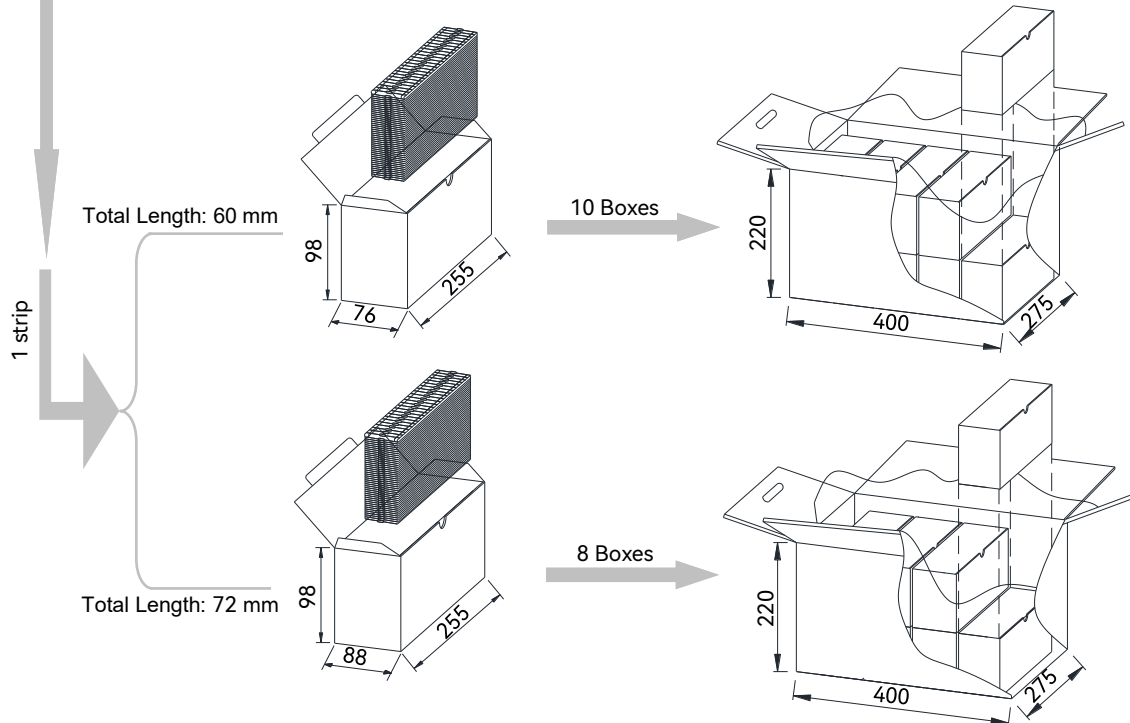
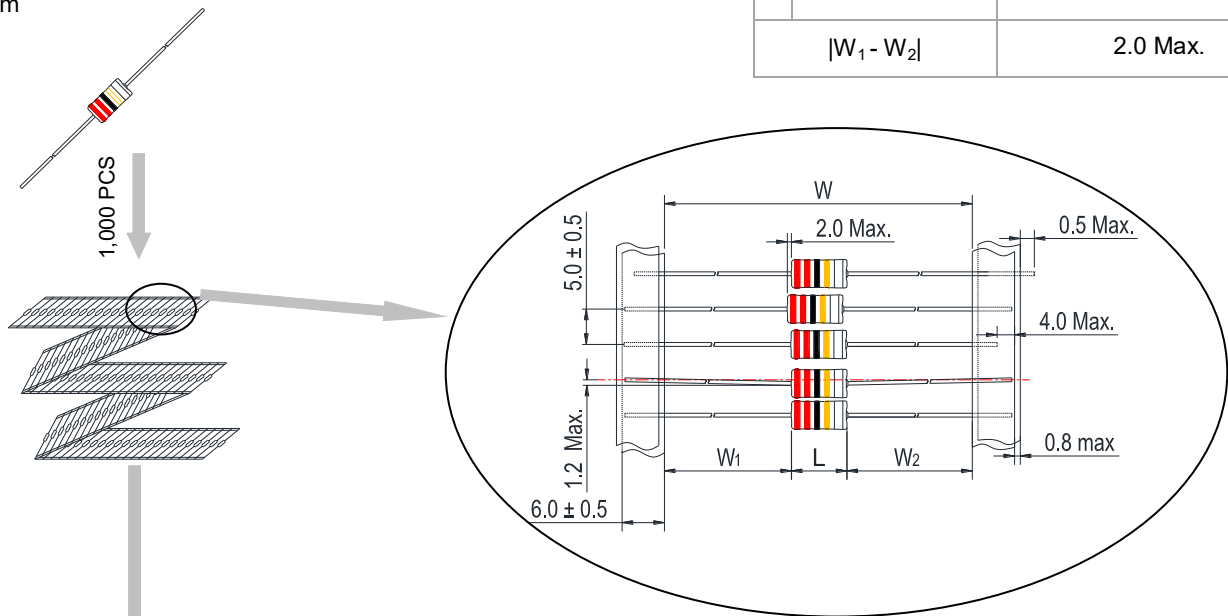

# TRXF

Thermal-Link & Fusing Resistor

## TRXF2 Series (Axial Type)

### Packaging Information

#### Vertical Taping

Item	Box	Carton
Quantity (PCS)	2,000	20,000
Gross Weight (kg)		7.5 ± 10%

Unit: mm

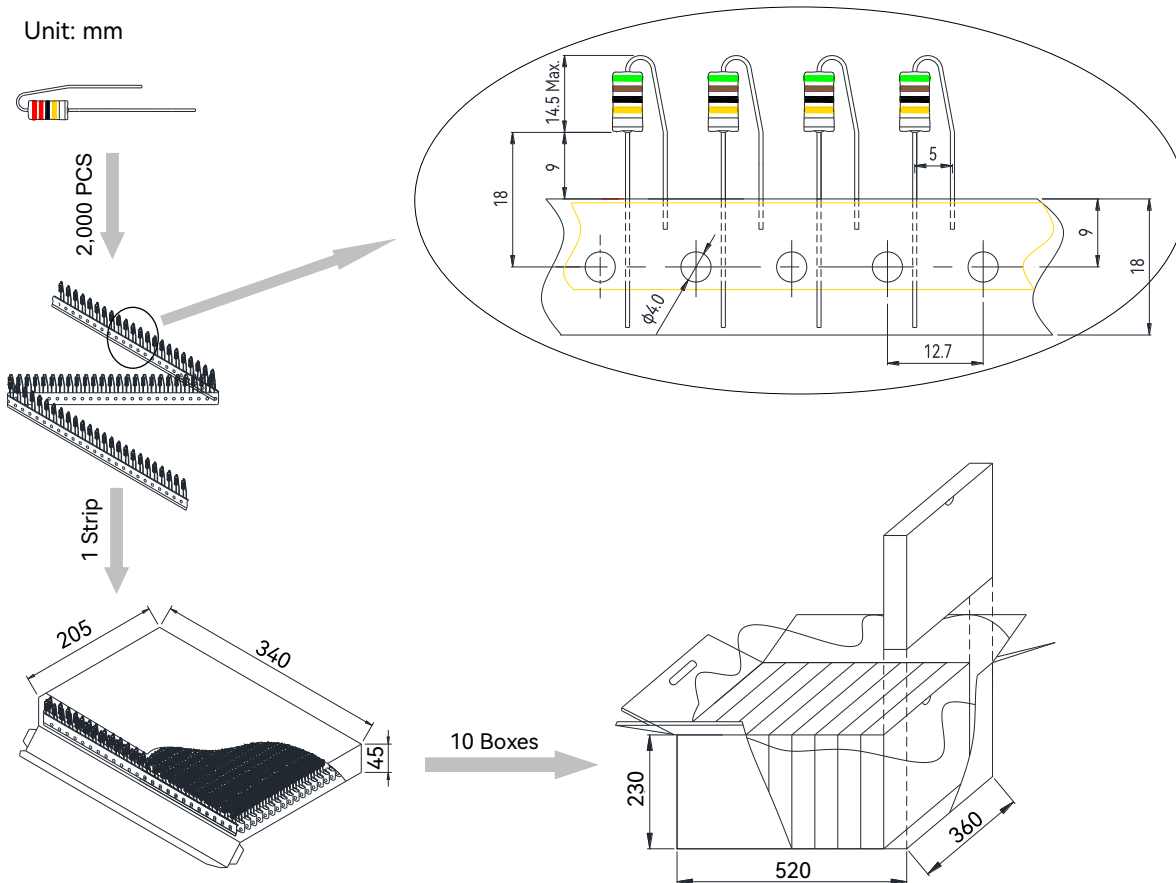

#### Bulk

Item	Bag	Plastic Tray	Carton
Quantity (PCS)	100	2,000	20,000
Gross Weight (kg)			12.5 ± 10%

Unit: mm

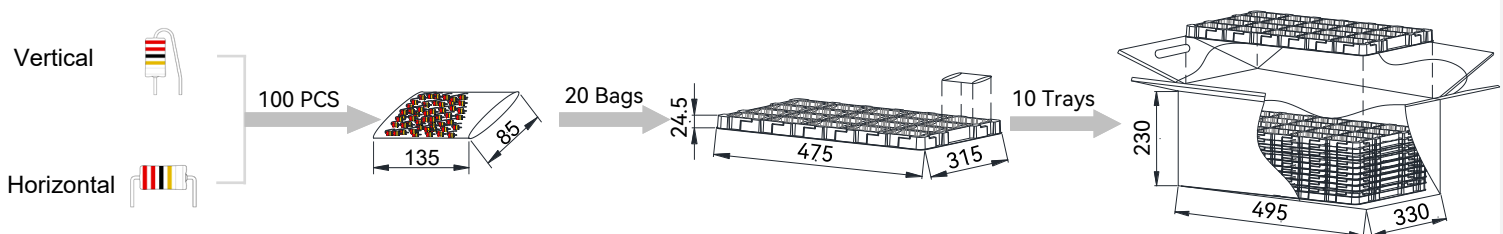

Glossary

Item	Description
RXF	<p><b>Fusible Wirewound Resistor</b></p> <p>A power resistor which is made by winding a resistive element on a ceramic core, and the core is coated by insulation coating. It intends to interrupt a current flow at a predetermined time when the current exceeds a predetermined value. Fusible Wirewound Resistor is disposable fuse elements and is non-recoverable.</p> <p>— (SETsafe   SETfuse Standards)</p>
ATCO	<p><b>Alloy Thermal-Link</b></p> <p>Alloy Type Thermal-Link, Alloy is the thermal element.</p> <p>— (GB/T 9816.3)</p>
R	<p><b>Rated Resistance</b></p> <p>Resistance value for which the resistor has been designed, and which is generally used for denomination of the resistor.</p> <p>— (IEC 60115-1)</p>
P <sub>0</sub>	<p><b>Actual Power</b></p> <p>The Max. power of TRXF can be used within the allowable operating Temp. range.</p> <p>— (SETsafe   SETfuse Standards)</p>
I <sub>N</sub>	<p><b>Rated Current</b></p> <p><math>I_N = \sqrt{P_0 / R}</math></p> <p>— (SETsafe   SETfuse Standards)</p>
U <sub>N</sub>	<p><b>Rated Voltage</b></p> <p>The d.c. or a.c. r.m.s. voltage calculated from the square root of the product of the rated resistance and the rated dissipation.</p> <p>— (IEC 60115-1)</p>
T <sub>f</sub>	<p><b>Rated Functioning Temp.</b></p> <p>The temp. of the Alloy Thermal-Link which causes it to change the state of conductivity with a detection current up to 10 mA as the only load.</p> <p>Tolerance: T<sub>f</sub> + 0 / -10 °C (GB 9816.1, EN 60691, K60691)</p> <p>Tolerance: T<sub>f</sub> ± 7 °C (J60691)</p> <p>— (IEC 60691)</p>
T <sub>F</sub>	<p><b>Fusing Temp.</b></p> <p>The temp. of the Alloy Thermal-Link which causes it to change its state of conductivity is measured with silicone oil bath in which the temp. is increased at the rate of 0.5 °C to 1 °C / minute, with a detection current up to 10 mA as the only load.</p> <p>— (IEC 60691)</p>
TCR	<p><b>Temp. Coefficient of Resistance</b></p> <p>Relative variation of resistance between two given temp. divided by the difference in the temp. producing it.</p> <p>— (IEC60115-1)</p>





# ATTENTION

## Cold Resistance Test

1. If product TCR is not less than 350 ( $10^{-6}/^{\circ}\text{C}$ ), the measured resistance value shall be corrected as the relative resistance value under 25 °C according to TCR formula.
2. Resistance Measurement (4-terminal test)

## Replacement

As TRXF is a non-resettable product, for safety sake, please use the same type of TRXF for replacement.

## Usage

1. Do not touch the resistor body or pins directly when power is on, to avoid burn or electric shock.
2. When air pressure is from 80 kPa to 106 kPa, the relative altitude shall be +2000 m to - 500 m.

## Storage

1. Please store TRXF with ambient temp. 10 °C ~ 30 °C and relative humidity 30% ~ 75%.
2. Do not store the TRXF at the high temp., high humidity or corrosive gas environment, avoid influencing the solderability of the pins, please use them up within 1 year after receiving the goods.

## Soldering Parameters

### Wave Soldering Parameters (For Reference Only)

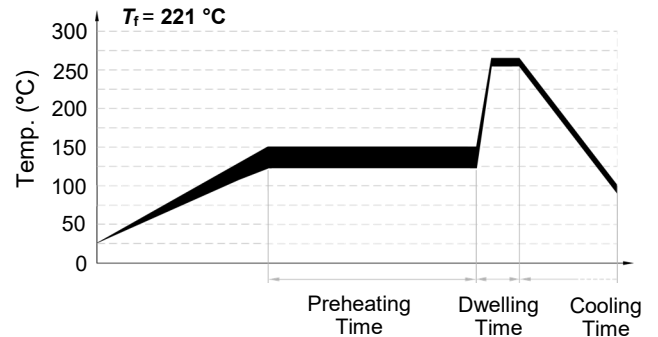

Item	Temp. (°C)	Time (s)
Preheating	$T_f=221^{\circ}\text{C}$	60 ~ 100
	120 ~ 150	
Dwelling	$260 \pm 5$	4 ~ 5

## Hand-Soldering Parameters

Solder Iron Temp.:  $(350 \pm 5)^{\circ}\text{C}$

Soldering Time:  $\leq 3\text{ s}$  ( $T_f = 221^{\circ}\text{C}$ )

**Thermal-Link & Fusing Resistor ( TRXF - Axial Type ) Features Overview**

<b>Shape</b>				
<b>Structure</b>	Coating	With Tube	Coating	With Tube
<b>R Resistance Range</b>	(0.27 ~ 800) Ω		(0.27 ~ 1000) Ω	
	According to IEC60063-2015, resistance can be customized.			
<b>P Power Type</b>	1 W		2 W	
<b>Dimensions</b>	Φ4.4 mm × 9.0 mm	Φ4.6 mm × 9.5 mm	Φ4.4 mm × 10 mm	Φ4.6 mm × 10.5 mm
	The forming modes and length of lead wires can be customized.			
<b>T<sub>f</sub> Rated Functioning Temp.</b>	221 °C			